

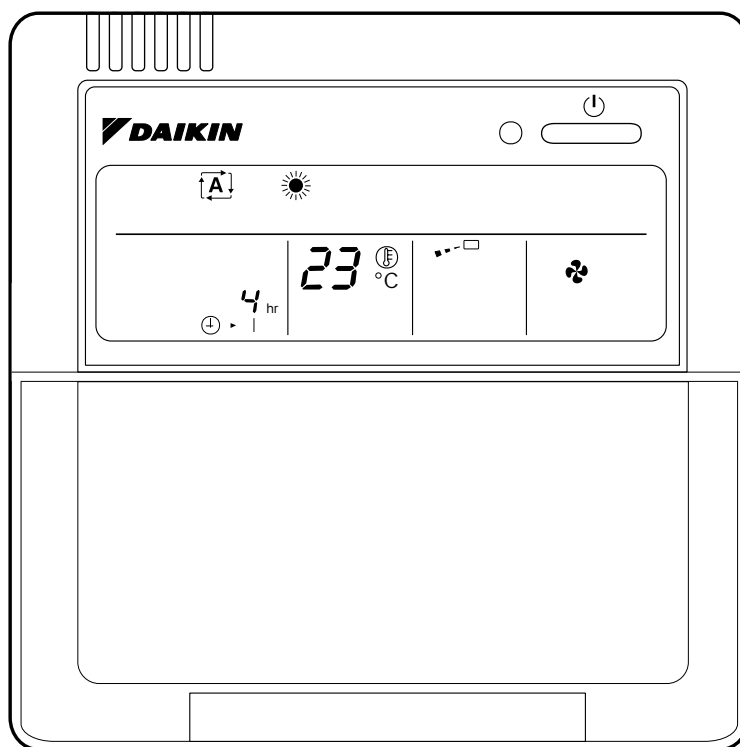

OPERATION MANUAL

SPLIT SYSTEM Ducted Air Conditioner

Using Remote Controller BRC1C61



Dear Owner,

Thank you for installing a DAIKIN Fully Ducted Air Conditioning System. We believe that you have purchased the best air conditioning system available.

Before operating the air conditioner please read this operating manual carefully. It will advise you on how to operate the unit correctly, understand the air conditioner's advanced features and help you in the unlikely event that a problem should occur.

Please keep this manual in a safe place for future reference.

DAIKIN AUSTRALIA PTY. LIMITED

SAFETY CONSIDERATIONS

We recommend that you read this instruction manual carefully before use to gain full advantage of the functions of the air conditioner and to avoid malfunction due to mishandling. This air conditioner comes under the term "appliances not accessible to the general public".

- The precautions described below are **WARNING** and **CAUTION**. These are very important precautions concerning safety. Be sure to observe all of them without fail.

⚠ WARNING These are the matters with possibilities leading to serious consequences such as death or serious injury due to erroneous handling.

⚠ CAUTION These are the matters with possibilities leading to injury or material damage due to erroneous handling including probabilities leading to serious consequences in some cases.

- After reading, keep this manual at a place where any user can read at any time. Furthermore, make certain that this operation manual is handed to a new user if required.

⚠ WARNING

- **Avoid prolonged exposure of your body to direct streams of cold air.**
Your physical condition may deteriorate.
- **If the air conditioner is in abnormal conditions (smell of something burning, etc.), switch the air conditioner off at the main switch, and contact the dealer where you purchased the air conditioner.**
Continued operation under such circumstances may result in a failure, electric shock or fire.
- **Only use a qualified installer for installation of the air conditioner.**
Incorrect installation performed may result in a water leakage, electric shock or fire.
- **Ask your dealer for improvement, repair, and maintenance.**
Incorrect improvement, repair, and maintenance may result in a water leakage, electric shock or fire.
- **Never remove any fixed covers on the indoor or outdoor unit.**
Removal of the covers may expose fast moving fan blades or electrical components operating at a hazardous voltage. Contact with the blades or high voltage components may result in injury or electric shock.
- **For refrigerant leakage, consult your dealer.**
If the air conditioner is to be installed in a small room, it is necessary to take proper measures so that the amount of any leaked refrigerant does not exceed the limiting concentration. If the refrigerant leaks exceeding the level of limiting concentration, an oxygen deficiency accident may happen.
- **For installation of separately sold component parts, ask a specialist only.**
Be sure to use separately sold component parts designated by Daikin. Incomplete installation performed by yourself may result in a water leakage, electric shock or fire.
- **Ask your dealer to move and reinstall the air conditioner.**
Incomplete installation may result in a water leakage, electric shock or fire.
- **Never insert any objects into the openings in the indoor or outdoor unit.**
This may damage the product or result in injury to the person inserting the object.

⚠ CAUTION

- **Do not use the air conditioner for other purposes.**
Do not use the air conditioner for special applications such as the storage of foods, animals and plants, precision machines, and art objects. Deterioration of quality may result.
- **When the air conditioner is used in combination with burners or heaters, ensure sufficient ventilation.**
Insufficient ventilation may result in an oxygen deficiency accident.
- **Regularly check the quality of the foundation blocks.**
If they are left in a damaged condition, the unit may fall and result in injury.
- **Do not place or use a flammable spray can near the air conditioner.**
Doing so may result in a fire.
- **To clean the air conditioner, stop operation and switch the power off at the main switch.**
Otherwise, an electric shock and injury may result.
- **Do not expose the indoor unit or remote controller to rain or moisture.**
Water or other fluids on the electrical components may result in fire or electric shock.
- **Always replace any blown fuse with a fuse of the same specification.**
The use of the wrong type fuse may allow the electrical wiring to overheat and catch on fire. If the correct type of fuse continues to blow contact your installer or electrician.
- **Do not place a burner or heater at a place directly exposed to the wind from the air conditioner.**
Incomplete combustion of the burner or heater may result.
- **This electrical appliance is not intended for use by young children or infirm persons without supervision.**
Young children should be supervised to ensure that they do not play with the outdoor unit.
- **Do not expose animals and plants directly to the air stream from the outdoor unit.**
Adverse influence to animals and plants may result.
- **Do not wash the air conditioner with water.**
An electric shock may result.
- **Do not install the air conditioner at any place where flammable gas may be present.**
If the gas leaks out and stays around the air conditioner, a fire may break out.
- **Execute complete drain piping for perfect drainage.**
Incomplete piping may result in a water leakage.
- **Never operate the air conditioner without the return air filter(s) in place.**
Operating the unit without the filter(s) will allow dust to enter the indoor unit and build up on the heat exchanger coil and fan motor. This will cause a malfunction of the unit which will not be covered by Warranty.

CONTENTS

SAFETY CONSIDERATION	2
WHAT TO DO BEFORE OPERATION	3
MAIN SWITCH	3
REMOTE CONTROLLER	4
IMPORTANT NOTES ABOUT INSTALLATION	4
FUNCTIONS OF THE REMOTE CONTROLLER	5
GENERAL OPERATION	6
ADVANCED FEATURES	8
OPTIMUM OPERATION	8
SELF DIAGNOSIS	9
NOT MALFUNCTION OF THE AIR CONDITONER	9
TROUBLE SHOOTING	10
USER MAINTENANCE	11

Fig. 1	4
Fig. 2	6
Fig. 3, 4	7
Fig. 5	9

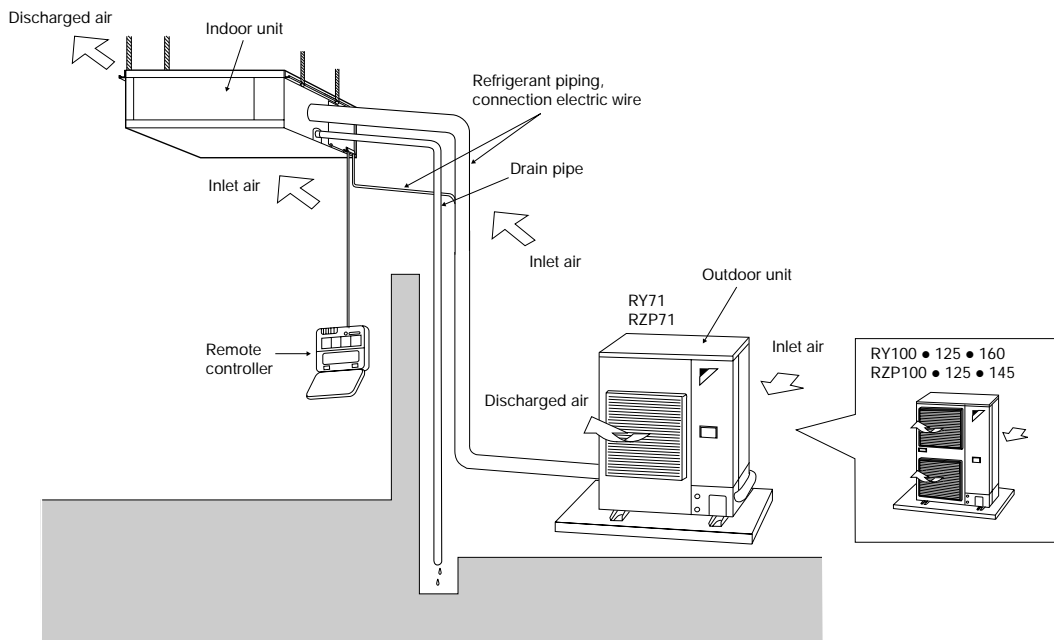

WHAT TO DO BEFORE OPERATION

This operation manual is for the following systems with standard control. Before initiating operation, contact your Daikin dealer for the operation that corresponds to your system.

If your installation has a customized control system (eg zone control) ask your Daikin dealer for the operation that corresponds to your system.

MAIN SWITCH

Ensure that your installer shows you the location of the main power switch of the air conditioning systems. This switch is normally located adjacent to the outdoor unit or in the fuse box / switchboard.

The main switch must be turned on at least 6 hours before the air conditioner is operated to warm up the compressor. Failure to do so may result in damage to the compressor which will not be covered by warranty.

If the air conditioner is not going to be used for an extended period of time or you are going away on holidays, the main switch should be turned off to prevent accidental operation of the air conditioner. Remember that the main switch must be turned back on at least 6 hours before operating the air conditioner.

REMOTE CONTROLLER

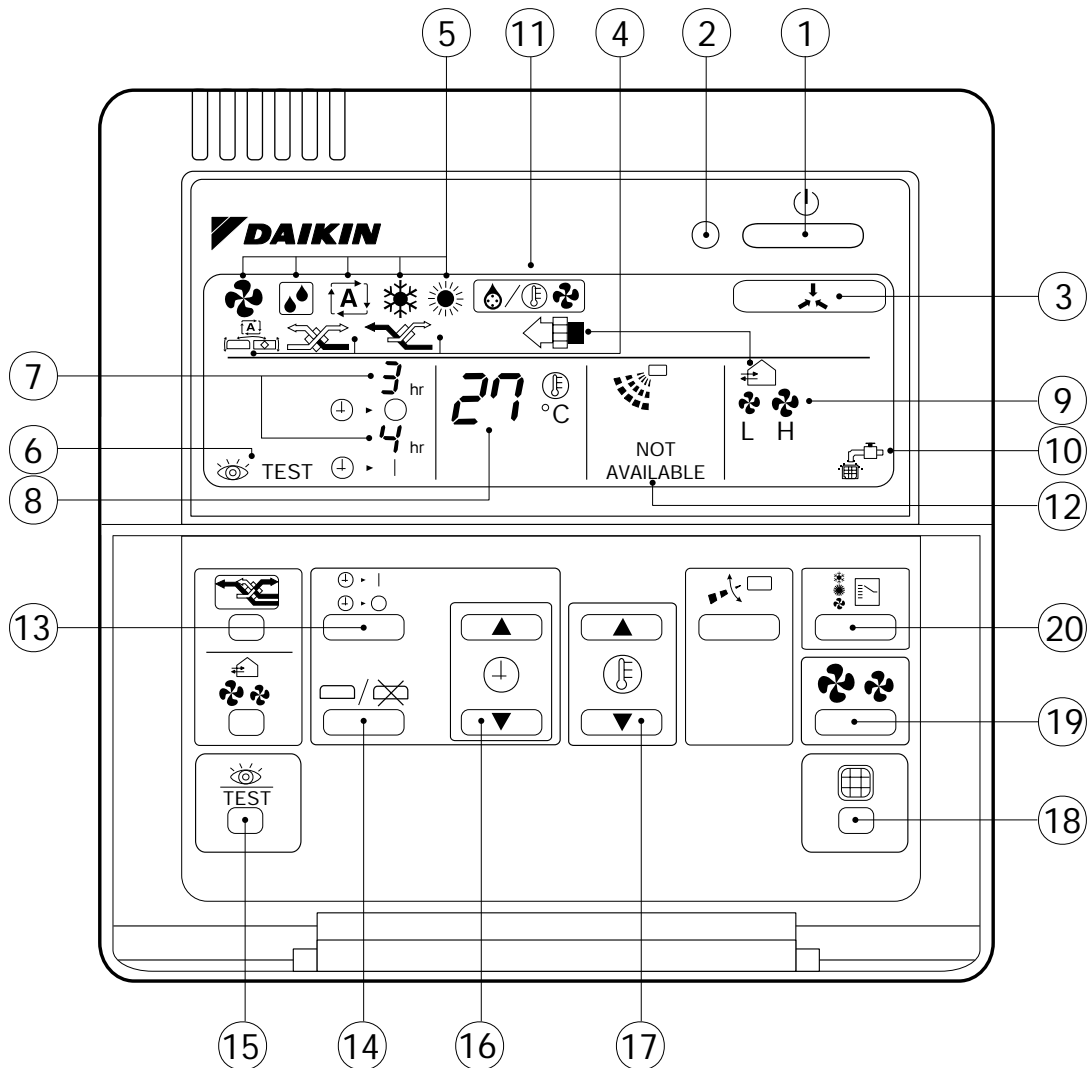

Fig. 1

IMPORTANT NOTES ABOUT INSTALLATION

















- **Ensure the outdoor unit is installed in:-**
 - a. A place that can sufficiently withstand the weight of the air conditioner with less running noises and vibrations.
 - b. A place where the hot air stream discharged from the air outlet of the outdoor unit and the running noises do not bother your neighbours.
- **Ensure that there are no obstacles near the air outlet of the outdoor unit.**
Obstacles such as plants, boxes, fences, etc. may result in declined performance and increased running noises.
- **If abnormal noises occur in use, consult your dealer.**
- **Ensure the drain piping from the indoor unit is free of blockage.**
During cooling operation, water should drip from the outlet of the indoor unit's drain piping. If there is no evidence of water from the drain outlet after several hours of cooling it may be that the drain is blocked or the relative humidity is low. If you think the drain is blocked stop the air conditioner and contact your installer.
- **Ensure that a separate power supply circuit is provided for this air conditioner.**
All electrical work is to be carried out by qualified personnel according to local laws and regulations.

FUNCTIONS OF THE REMOTE CONTROLLER

All controls except for the ON / OFF BUTTON are located behind a swing door on the bottom half of the remote controller. To access these controls simply open the door by gently pulling down on the finger grip located on the top right hand edge of the door. To close the door simply swing it back up until it clicks into the closed position.

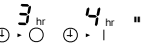
Once the desired temperature, fan speed and mode of operation have been set there is no need to access the controls behind the door. Basic operation of the air conditioner is simply a matter of pressing the ON / OFF BUTTON.

Please note that the selected temperature, fan speed and mode of operation will always be displayed even when the air conditioner is not operating.

1	ON/OFF BUTTON	12	NON FUNCTIONING DISPLAY
	Press the button to start or stop the air conditioner.		If a particular function is not available, pressing the button may display the words "NOT AVAILABLE" for a few seconds. When running multiple units simultaneously the "NOT AVAILABLE" message will only appear if none of the indoor units is equipped with the function. Even if one unit is equipped, the display will not appear.
2	OPERATION INDICATOR	13	TIMER MODE START / STOP BUTTON
	This indicator illuminates (RED) when the air conditioner is operating.		Press this button to select the setting for timer stop. Press the button a second time to select the setting for timer start.
3	CENTRALISED CONTROL INDICATOR "  "	14	PROGRAM TIMER ON / OFF BUTTON
	This symbol indicates that the air conditioner is under control from an optional centralised control panel.		Press this button after entering the desired off/on time to initiate the timer function.
4	HEAT RECLAIM VENTILATION / AIR CLEANING "  " "  " "  " "  " "	15	INSPECTION / TEST OPERATION BUTTON
	This symbol indicates that the optional Heat Reclaim Ventilation Unit is operating. (for commercial use).		This button is for use by installation or service technicians only.
5	OPERATION DISPLAY "  " "  " "  " "  " "  " " Fan Dry Auto Cool Heat	16	PROGRAM TIME BUTTON
	This display shows the current OPERATION MODE. For cooling only type, "  " (Auto) and "  " (Heating) are not selectable.		Push on the up arrow to increase the desired program stop / start time. Push on the down arrow to decrease the desired program stop / start time.
6	INSPECTION / TEST INDICATOR "  TEST "	17	TEMPERATURE SET BUTTON
	This symbol flashes to indicate that TEST / INSPECTION BUTTON has been pressed or that the microprocessor has determined that a fault condition has occurred.		Push on the up arrow to increase the desired room temperature. Push on the down arrow to decrease the desired room temperature.
7	PROGRAM TIME INDICATOR "  " "	18	FILTER CLEAN RESET BUTTON
	These symbols and numbers indicate the programmed stop (off) and start (on) time.		Press this button to reset the CLEAN FILTER INDICATOR after you have inspected / cleaned the indoor return air filter.
8	SELECTED TEMPERATURE DISPLAY "  " "	19	FAN SPEED SELECTOR BUTTON
	This display indicates the desired room temperature.		Press this button to toggle between high and low fan speed.
9	FAN SPEED DISPLAY "  " "	20	OPERATION MODE SELECTOR BUTTON
	This display indicates the selected fan speed (ie. high or low).		Press this button to change the desired mode of operation. (ie. fan, program dry, auto, cool, heat).
10	FILTER CLEAN INDICATOR "  " "	NOTE:	● For the sake of explanation, all indications are shown on the display in Fig. 1 contrary to actual running situation.
	This symbol indicates that the indoor return air filter may require cleaning.		
11	DEFROST INDICATOR "  " "		

GENERAL OPERATION

COOLING (see Fig. 2)

1. Press the MODE SELECTION BUTTON (20) (if required) until the COOL MODE INDICATOR (☀️) is displayed.
2. Select the desired room temperature (if required) by momentarily pressing on the up or down arrow TEMPERATURE SET BUTTON's (17) until the desired temperature is displayed. Each press of the button will increase or decrease the desired temperature by 1 degree. The desired temperature may be set in the range of 16 - 32 degrees.
3. Press the ON / OFF BUTTON (1) to commence operation. The OPERATION INDICATOR (2) will illuminate.
4. Select the desired fan speed (if required) by pressing the FAN SPEED SELECTOR BUTTON (19).
5. To turn the air conditioner off simply press the ON / OFF BUTTON (1). The OPERATION INDICATOR (2) will turn off.

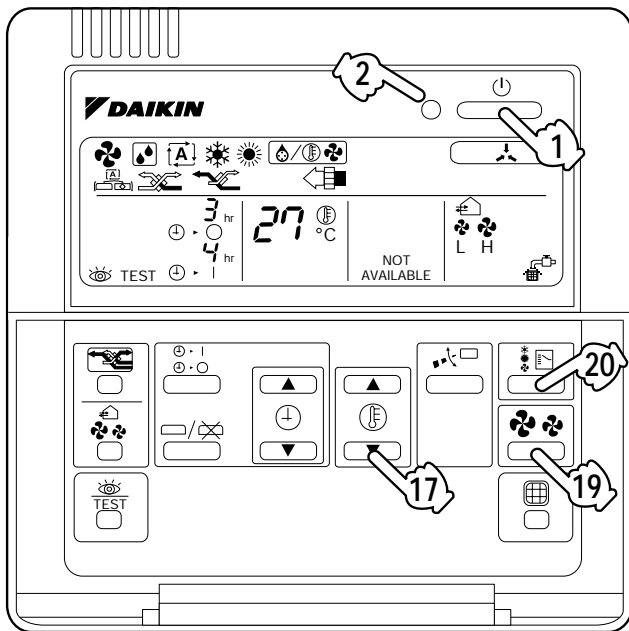

Fig. 2

HEATING (Heat Pump Models Only) (see Fig. 2)

1. Press the MODE SELECTION BUTTON (20) (if required) until the HEAT MODE INDICATOR (☀️) is displayed.
2. Select the desired room temperature (if required) by momentarily pressing on up or down arrow TEMPERATURE SET BUTTON's (17) until the desired temperature is displayed. Each press of the button will increase or decrease the desired temperature by 1 degree. The desired temperature may be set in the range of 16 - 32 degrees.
3. Press the ON / OFF BUTTON (1) to commence operation. The OPERATION INDICATOR (2) will illuminate.

4. Select the desired fan speed (if required) by pressing the FAN SPEED SELECTOR BUTTON (19).

Notes:

As the air conditioner incorporates a hot start system, the indoor fan will run at an extra low (or low) speed irrespective of the selected fan speed for a few minutes when the unit is first turned on. This is to avoid cold draughts.

During the heating mode you may notice the indoor fan changing speed. This is due to the fan switching from the selected fan speed to extra low (or low) when the desired room temperature is reached and the compressor cycles off.

This is to avoid cold draughts.

5. To turn the air conditioner off simply press the ON / OFF BUTTON (1). The OPERATION INDICATOR (2) will turn off.

Note:

On some occasions the indoor fan will continue to run at extra low (or low) speed for approximately one minute after the unit has been switched off. This is not a malfunction, it is simply a function of the unit which runs the indoor fan to remove any excess heat in the indoor unit heat exchanger.

AUTOMATIC HEATING / COOLING CHANGEOVER (Heat Pump Models Only) (see Fig. 2)

When the air conditioner is operated in this mode, it will automatically switch between the heating and cooling modes, depending on the room temperature and set temperature.

PMV Control (for Super Inverter Models only)

When in the automatic cool / heat changeover mode, the Predicted Mean Vote (PMV) control is activated. By initially manually increasing or decreasing the set temperature in this mode (for increased comfort) over a period of time, the PMV control "learns" and "remembers" these temperature settings as well as prevailing conditions - both inside and outside.

When similar conditions occur again, the system automatically controls the temperature settings according to the learnt preferences. This not only can save in running costs (as it avoids over cooling and over heating) but can also increase comfort levels.

1. Press the MODE SELECTION BUTTON (20) (if required) until the AUTO MODE INDICATOR (⌈A⌋) is displayed.

When the AUTO MODE is selected either the COOL or HEAT MODE INDICATOR will also be displayed along with the most recent temperature setting. (ie. if the last adjustment you made was to set the cooling mode temperature to 23° then when you select the AUTO MODE it will display AUTO COOLING at a temperature of 23°). The air conditioner will then measure the room temperature and select the applicable mode (ie. heating or cooling) based on the current and desired room temperature.

- Adjust the desired room temperature (if required) by momentarily pressing on the up or down arrow TEMPERATURE SET BUTTON's (17) until the desired temperature is displayed. Each press of the button will increase or decrease the desired temperature by 1 degree. The desired temperature may be set in the range of 16 - 32 degrees.
- Press the ON / OFF BUTTON (1) to commence operation. The OPERATION INDICATOR (2) will illuminate.
- Select the desired fan speed (if required) by pressing the FAN SPEED SELECTOR BUTTON (19).
- To turn the air conditioner off simply press the ON / OFF BUTTON (1). The OPERATION INDICATOR (2) will turn off.

PROGRAM DRY MODE (see Fig. 3)

When the air conditioner is operated in this mode the microprocessor will give priority to reducing the humidity level rather than the room temperature. (Please note that there may still be some reduction in room temperature depending on ambient conditions). This mode is normally used in very humid environments where the conditions may still be uncomfortable even though the room temperature is fairly low. The air conditioner will not enter the dry mode if the room temperature is below 16°C.

- Press the MODE SELECTION BUTTON (20) (if required) until the DRY MODE INDICATOR () is displayed.
- Press the ON / OFF BUTTON (1) to commence operation. The OPERATION INDICATOR (2) will illuminate.
- To turn the air conditioner off simply press the ON / OFF BUTTON (1). The OPERATION INDICATOR (2) will turn off.

Please note that the SELECTED TEMPERATURE DISPLAY (8) and FAN SPEED DISPLAY (9) will not appear during PROGRAM DRY operation.

FAN MODE (see Fig. 2)

When the air conditioner is operated in the FAN MODE only the indoor fan is energised. The outdoor unit will not operate and therefore heating or cooling will not be provided. This mode is useful for circulating the air within the building.

- Press the MODE SELECTION BUTTON (20) (if required) until the FAN MODE INDICATOR () is displayed.
- Press the ON / OFF BUTTON (1) to commence operation. The OPERATION INDICATOR (2) will illuminate.
- Select the desired fan speed (if required) by pressing the FAN SPEED SELECTOR BUTTON (19).

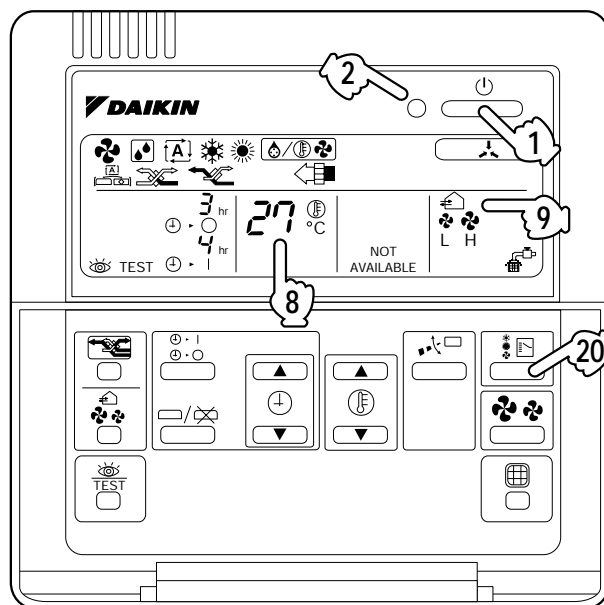

Fig. 3

- To turn the air conditioner off simply press the ON / OFF BUTTON (1). The OPERATION INDICATOR (2) will turn off.

Please note that the SELECTED TEMPERATURE DISPLAY (8) will not appear during FAN MODE operation.

PROGRAM TIMER

The air conditioner can be programmed to automatically turn on or off in 1 hour increments up to 72 hours in advance. It may also be programmed to turn on for a determined time then off again or vice versa provided that the last operation (ie. switch on or off) is within 72 hours.

PROGRAMMING THE START / STOP TIME (see Fig. 4)

- Press the TIMER MODE START/STOP BUTTON (13) once to enter the program STOP mode, or twice to enter the program START mode. The symbol "O" indicates STOP, and "|" START. The PROGRAM START/STOP TIME INDICATOR (7) will flash.
- Select the desired START/STOP TIME by momentarily pressing on the up or down arrow PROGRAM TIME BUTTON's (16) until the desired elapsed time is displayed. Each press of the button will increase or decrease the elapsed time by 1 hour.
- Once the desired START/STOP TIME is displayed press the PROGRAM TIMER ON/OFF BUTTON (14). The PROGRAM START or STOP TIME INDICATOR (7) will stop flashing and remain displayed.
- Operate the air conditioner in the desired mode as described above. The PROGRAM START/STOP TIME INDICATOR (7) will count down towards zero. When zero is reached the air conditioner will start or stop operating depending on the program set.

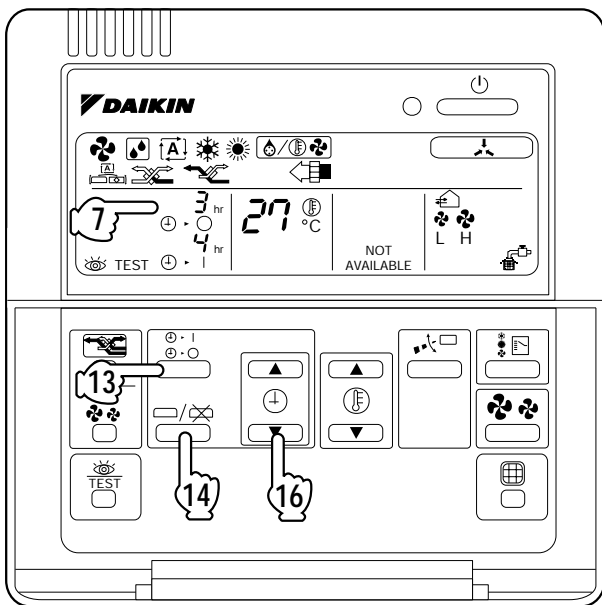

Fig. 4

It is possible to set both the start and stop time so that the air conditioner either starts after a predetermined time and then stops after a further predetermined time or stops after a predetermined time and then starts again after a further predetermined time.

This is achieved by setting both the on and off time as described above. For example if you require the air conditioner to stop in 3 hours time and then start up again 6 hours later you would program a stop time of 3 hours and a start time of 9 hours (ie. 3 + 6 hours).

CANCELLING THE START OR STOP TIME

If you change your mind and do not want the air conditioner to automatically start or stop simply press the PROGRAM TIMER ON/OFF BUTTON (14) and the START or STOP TIME INDICATOR will extinguish.

15.8 Advanced Features

DEFROST FUNCTION (Heat Pump Models only)

During heating at low outside air temperatures it is possible for frost to build up on the outdoor unit heat exchanger. This build up of frost will restrict the airflow through the heat exchanger and therefore the performance of the air conditioner will gradually be reduced. As the outdoor unit microprocessor is constantly monitoring system performance and ambient temperature it will recognise that frost is building up on the heat exchanger and activate defrost operation.

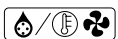
When the unit enters the defrost mode both the indoor and outdoor fans will stop and the DEFROST INDICATOR () will be displayed on the remote control. The unit will remain in the defrost mode for around 4 to 8 minutes (10 min. max.) during which time the heat exchanger will warm up to defrost itself. than 1°C below the selected temperature.

HOT START SYSTEM (Heat Pump Models only)

To prevent a cold draft when the air conditioner turns on in the heating mode the indoor unit incorporates a computer controller hot start system.

The indoor unit microprocessor monitors the temperature of the indoor heat exchanger and operates the indoor fan at a speed lower than the normal low until the heat exchanger temperature reaches a target temperature. When this target is reached the fan switches from extra low to set speed. (FDY90 operates at low speed)

This hot start feature is also utilised after defrost and during the heating cycle when the compressor switches back on after the room temperature has fallen more than 1°C below the selected temperature.

AUTOMATIC RESTART AFTER POWER FAILURE

If the air conditioner is operating during a power failure it will automatically restart in the same mode when the power is restored.

DUAL REMOTE CONTROL OPERATION (Optional)

A second (optional) remote control may be added to the system to allow setting and control of the unit at two different locations. This is particularly useful in two storey applications where one controller can be installed upstairs and the other controller downstairs. When dual controls are used the air conditioner will obey the last command entered into either controller. Both controllers will display the same information so if the temperature on the downstairs controller is increased from 21 to 23 degrees, the upstairs controller will also indicate 23 degrees. This feature is not available if the optional set back time clock (BRC15A61) is used.

NOTE: Program Timer setting is not possible from the second (optional) remote controller.

15.9 Optimum Operation

Observe the following precautions to ensure the system operates efficiently.

- Adjust the room temperature for a comfortable environment. Avoid excessive heating or cooling.
- Prevent direct sunlight from entering a room during cooling operation by using curtains or blinds.
- Keep doors and windows closed. If the doors and windows remain open, room air will flow out and decrease the effect of cooling and heating.
- Never place objects near the air inlet and the air outlet of the unit. It may retard effectiveness or cause operation to stop.

- Turn off the main power supply switch when not using for long periods of time. Electricity is consumed as long as the switch is on. Turn off the main power supply switch in order to save energy. Turn on the main power supply switch 6 hours before restarting operation in order to ensure smooth operation. (Refer to MAINTENANCE)
- Ventilate the room regularly.
Using the unit for long periods of time requires regular ventilation of the room.
- When the display shows "  " (TIME TO CLEAN THE AIR FILTER), clean the filter(s). (Refer to MAINTENANCE)

OPERATION RANGE

If the temperature or the humidity is outside the following conditions, safety devices may work and the air conditioner may not operate.

Cooling		Temperature (°C)		
Indoor	DB	19 to 35	WB	12 to 25 (Humidity 80% or below)
Outdoor	DB	-5 to 46		-

Heating		Temperature (°C)		
Indoor	DB	10 to 27		-
Outdoor	DB	-9 to 21	WB	-10 to 15

DB: Dry bulb temperature
WB: Wet bulb temperature

15.10 Self Diagnosis

In the unlikely event that a fault develops with the air conditioner the microprocessor in the indoor and outdoor units will diagnose the fault (where possible), display a unique fault code on the remote controller (see below) and flash the OPERATION INDICATOR (2) on and off. If this occurs take a note of the fault code (eg. A1) and contact your installer. This code will indicate to the installer / repairer what the problem may be.

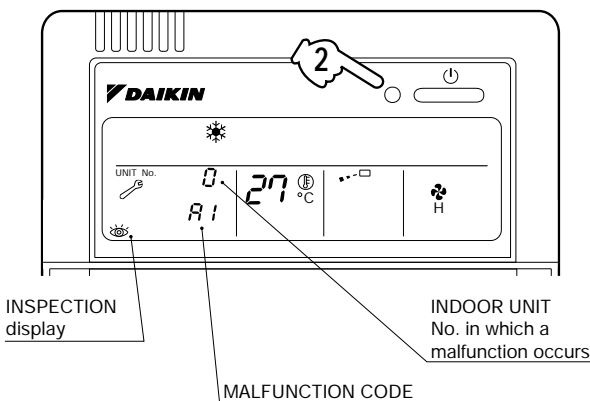
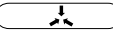

Fig. 5

15.11 Not Malfunction of the Air Conditioner

The following symptoms do not indicate that the air conditioner has malfunctioned.

THE SYSTEM DOES NOT OPERATE

- **The system does not restart immediately after the ON / OFF button is pressed.**
If the OPERATION lamp lights, the system is in its normal operating condition.
It may not restart immediately because one of its safety devices has actuated to prevent the system from being overloaded. The system will turn on again automatically after the passage of three minutes.
- **The system does not restart immediately when the TEMPERATURE SETTING button is returned to its former position after pushing.**
If the OPERATION lamp lights, the system is in its normal operating condition.
It may not restart immediately because one of its safety devices has actuated to prevent the system from being overloaded. The system will turn on again automatically after the passage of three minutes.
- **The system does not start when the display shows "  " (UNDER CENTRALIZED CONTROL) and it flashes for few seconds after pressing an operation button.**
This is because the system is under centralized control. Flashes on the display indicates that the system cannot be controlled by the remote controller.
- **The system does not start immediately after the power supply is turned on.**
Wait one minute until the micro computer is prepared for operation.
- **The outdoor unit is stopped.**
This is because the room temperature has reached the set temperature. The indoor unit switches to fan operation.

WHITE MIST COMES OUT OF THE OUTDOOR UNIT

- **When the system reverts to HEATING OPERATION after DEFROST OPERATION.**
Moisture generated by DEFROST becomes steam and is discharged.

NOISE FROM THE AIR CONDITIONER

- **A ringing sound in the outdoor unit after it is started.**
This sound is generated by the temperature regulator working.
It will quieten down after about a minute.
- **A continuous low "shuh" sound is heard when the system is in COOLING or DEFROST OPERATION.**
This is the sound of refrigerant gas flowing through both indoor and outdoor units.
- **A "shuh" sound which is heard at the start or immediately after the stop of operation or which is heard at the start or immediately after the stop of DEFROST OPERATION.**
This is the noise of refrigerant stopping or changing direction.

DUST FROM THE AIR CONDITIONER

- **Dust may blow out from the unit after starting operation from long resting time.**
Dust that has settled in the unit is blown out.

THE AIR CONDITIONER GIVES OFF ODOURS

- The unit absorbs the smell of rooms, furniture, cigarettes, etc., and then emits them.

THE LIQUID CRYSTAL OF THE REMOTE CONTROLLER SHOWS "88"

- **Happens immediately after the main power supply switch is turned on.**
Shows that the remote controller is in normal condition. Continues temporarily.

TROUBLE SHOOTING

If one of the following malfunctions occurs, take the measures shown below and contact your Daikin dealer.

The system must be repaired by a qualified service person.

WARNING

- **When the air conditioner is in abnormal conditions (smell of something burning, etc.), switch off the main switch, and contact your dealer**
Continued operation under such circumstances may result in a failure, electric shock, or fire.

- If a safety device such as a fuse, a circuit breaker, or an earth leakage circuit breaker frequently actuates, or ON/OFF switch does not properly work.
Measure: Turn off the main power switch.
- If water leaks from unit.
Measure: Stop the operation.
- If the display "  " (INSPECTION), "UNIT No.", and the OPERATION lamp flash (2) and the "MALFUNCTION CODE" appears.

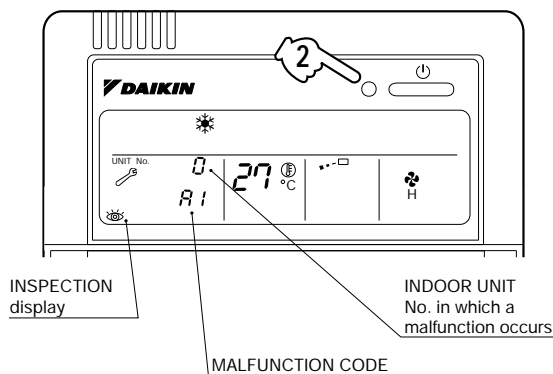

Measure: Notify your Daikin dealer and inform him/her of the display.

If the system does not operate properly and none of the above mentioned malfunctions is evident, investigate the system according to the following procedures.

1. **If the system does not operate at all.**
 - Check if there is a power failure.
Wait until power is restored. If power failure occurs during operation, the system automatically restarts immediately after the power supply recovers.
 - Check if the fuse has blown or circuit breaker has tripped. Change the fuse or re-set the circuit breaker.
2. **If the system stops operating after operating for a while.**
 - Check if the air inlet or outlet of outdoor or indoor unit is blocked by obstacles.
Remove the obstacle and make it well-ventilated.
 - Check if the air filter is clogged.
Clean the air filter(s). (Refer to MAINTENANCE)

3. The system operates but it does not sufficiently cool or heat.

- Check if the air inlet or outlet of the indoor or the outdoor unit is blocked with obstacles.
Remove the obstacle and make it well-ventilated.
- Check if the air filter is clogged.
Clean the air filter(s). (Refer to MAINTENANCE)
- Check if the set temperature is not proper. (Refer to OPERATION PROCEDURE)
- Check if the FAN SPEED CONTROL button is set to LOW SPEED. (Refer to OPERATION PROCEDURE)
- Check if the doors or the windows are open. Shut doors or windows to prevent wind from coming in.
- Check if direct sunlight enters the room.
(when cooling) Use curtains or blinds.
- When there are too many occupants in the room.
(when cooling) Cooling effect decreases if heat gain of the room is too large.
- Check if the heat source of the room is excessive.
(when cooling) Cooling effect decreases if heat gain of the room is too large.

USER MAINTENANCE

IMPORTANT!

- **NO USER SERVICEABLE PARTS ARE INSIDE THE AIR CONDITIONER. DO NOT REMOVE ANY ACCESS PANELS OR FIXED COVERS.**
- Before cleaning the air conditioner, be sure to stop operation, and turn the power switch off. Otherwise, an electric shock and injury may result.
- Do not wash the indoor unit with water.
Doing so may result in an electric shock.
- Be careful with a scaffold or staging.
Caution must be exercised because of work at a high place.

CLEANING THE AIR FILTER(S)

- Be sure to always clean the air filter(s) before use at the beginning of summer and winter. (Dirt and dust caught in the air filter causes a drop in airflow, which leads to a decline in performance.)
- When using the unit in a location where dirt may easily accumulate, clean the filter(s) more frequently. Once every 2 weeks is recommended.

NOTE

The air filter(s) and the suction grille(s) are supplied by your dealer.

Ask your DAIKIN dealer how to clean them.

HOW TO CLEAN AIR OUTLET GRILLE

- Clean with soft cloth.
- When it is difficult to remove stains, use water or neutral detergent.

NOTE

- Do not use gasoline, benzene, thinner, polishing powder, liquid insecticide. It may cause discoloring or warping.
- Do not let the indoor unit get wet. It may cause an electric shock or a fire.

MAINTENANCE OF THE OUTDOOR UNIT

- Regularly inspect the outdoor unit to ensure the heat exchanger coil (aluminium fins) and fan outlet are not obstructed by vegetation or any other foreign objects.
- Clean the outdoor unit heat exchanger coil annually or as required by location or outdoor air quality. The coil may be cleaned by spraying the fins with low pressure water in a downwards direction (ie. simulating heavy rain). Alternatively have the work done by your installer.
- Regularly check the paint work of the outdoor unit for scratches or signs of corrosion. Apply touch up or anti-corrosion paint as necessary.

START UP AFTER A LONG STOP

Confirm the following

- Check that the air inlet and outlet are not blocked.
Remove any obstacle.

Clean the air filter(s) and outside grille

- After cleaning the air filter, make sure to reattach it.

Turn on the main power supply switch

- The display on the remote controller will be shown when the power is turned on.
- To protect the unit, turn on the main power switch at least 6 hours before operation.

WHAT TO DO WHEN STOPPING THE SYSTEM FOR A LONG PERIOD

Turn on FAN OPERATION for a half day and dry the unit.

- Refer to "FAN OPERATION".

Cut off the power supply.

- When the main power switch is turned on, some power is being used even if the system is not operating.
Turn off the main power supply switch for saving energy.
- The display on the remote controller will vanish when the main power switch is turned off.

DAIKIN AUSTRALIA PTY. LIMITED

77-83 Alfred Road, Chipping Norton, NSW 2170 Australia
Customer Service: 1300 787 266

www.daikin.com.au

DAIKIN INDUSTRIES LTD.

Head office:

Umeda Centre Building, 4-12 Nakazaki-Nishi 2 chome,
Kita-ku, Osaka, 530-8323 Japan

Tokyo office:

Shinjuku Sumitomo Building, 6-1 Nishi-Shinjuku
2 chome, Shinjuku, Tokyo, 163-0290 Japan